

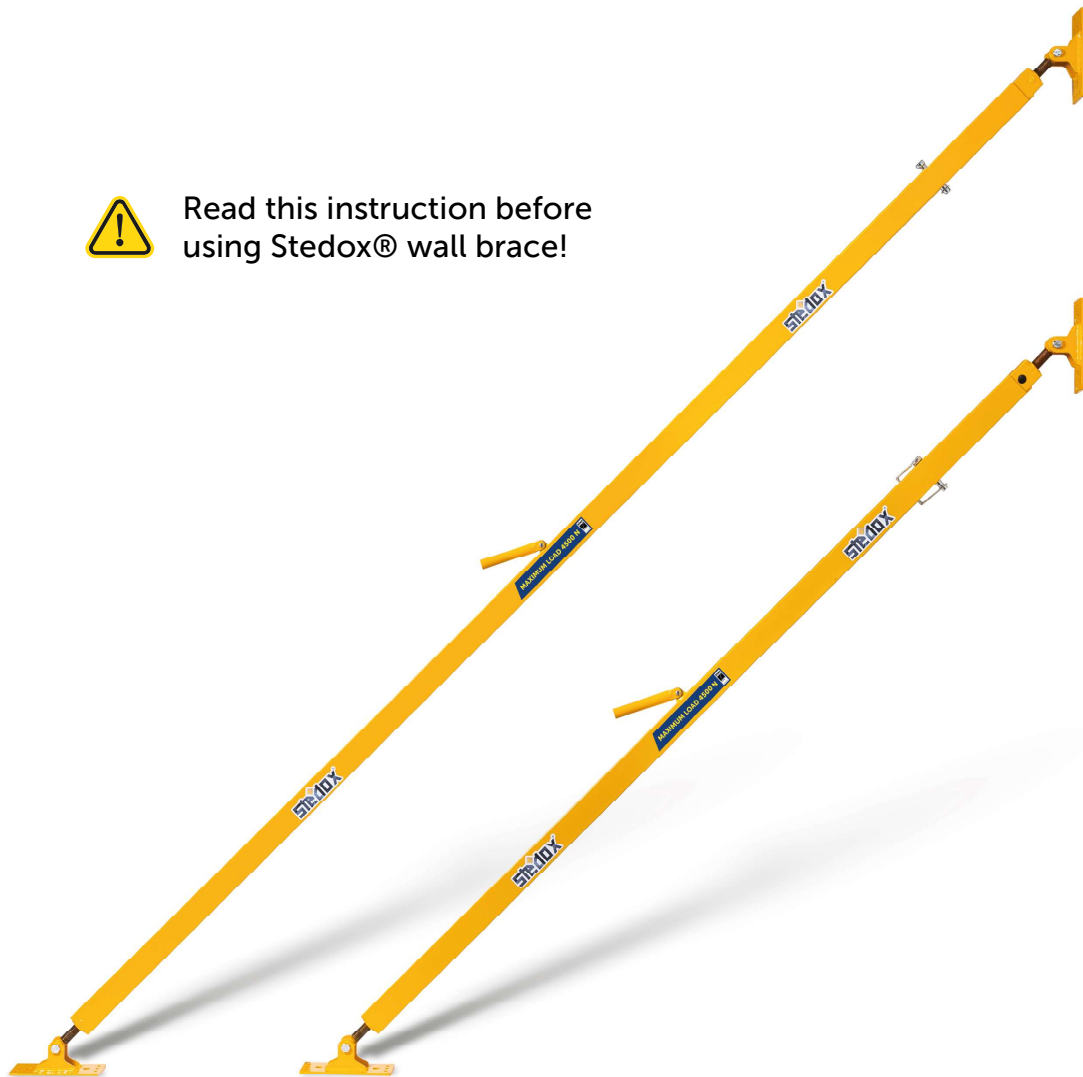

Read this instruction before
using Stedox[®] wall brace!



Customer service
Dennis Sundström
dennis@stedox.com
+358 (0)44 206 3020

Table of contents

Stedox® Support Operating Instructions	1
Customer service	1
1. Stedox®	3
2. Briefly about the product Stedox® Support	3
3. General	5
4. Safety and operating instructions	5
4.1 Symbols	5
4.2 Risk assessment	5
4.3 Installation instructions	5
4.4 Use	6
4.5 Information on the construction site	6
4.6 Illustrations	6
4.7 Checking the wall brace	6
4.8 Use of other products	6
5. Technical specification	7
5.1 End bracket geometry	8
6. Structural values	8
6.1 Load table	8
6.2 Load chart	8
7. Note	10
8. Service and spare parts	10
9. Handling	10
10. Storage	10
11. In case of an accident	10
4 Reasons to choose Stedox®	11



1. Stedox®

Stedox® is a brand owned by the Finnish company Stedox Ab Oy, Stedox® develops and sells products for easy element installations. Stedox® Support (hereinafter "Wall brace") is used to erect and install prefabricated elements, panels and columns,

2. Briefly about the product Stedox® Support

Stedox® Support is a wall brace designed specifically for timber structures. Recognizing the lack of safe and durable options in the market, the founders of Stedox® embarked on creating a lightweight and durable wall brace from scratch. Stedox® Support wall braces have so far gained popularity in Finland, Sweden, Norway, Denmark, Germany, USA, and Canada.

To use the wall brace, follow these steps:

1. Extend the brace to the desired length using its telescopic function in 100 mm increments.
2. Lock the brace in place using the locking pin.
3. Attach the brace to both the wall and floor securely.
4. Utilize the fine adjusting function by rotating the brace.

Benefits – that stedox® guarantee

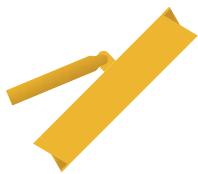

Extra sturdy handle gives you full control of the walls with only one hand

The extra sturdy handle enables you to install and adjust hundreds of panels per day without getting your hands tired

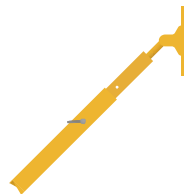

Rough adjustment is done quickly with a locking pin

The simplicity of the rough adjustment makes it possible for just one installer to have complete control of the panel

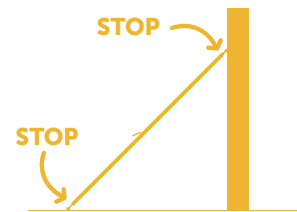

Built-in stop functions make the supports safe for the builders

Built-in stop functions make Stedox® Support very safe and prevent the panels from falling over

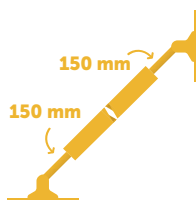

300 mm fine adjustment that makes it easy to adjust the wall straight

After attaching the wall bracing the length is fine-adjusted by rotating the support clockwise or counterclockwise. The length changes 5 mm per 360° rotation



Double rust protection ensures a long lifetime for the wall bracings

Stedox® wall bracings are hot-dip galvanized and powder coated to maximize their lifetime. The double rust protection implies the endurance of moist and cold conditions.

**12/16
KG**

Sturdy, yet lightweight and easy-to-use makes the work more efficiently

The wall bracings are designed to be easy to handle which makes the installation work more efficient

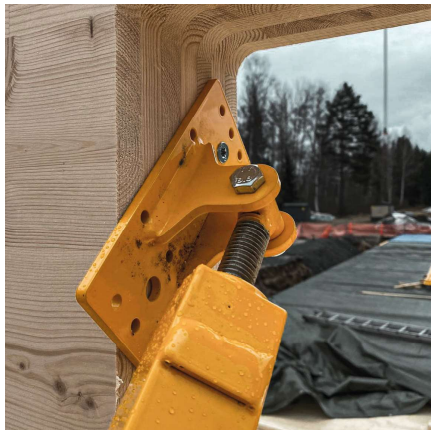
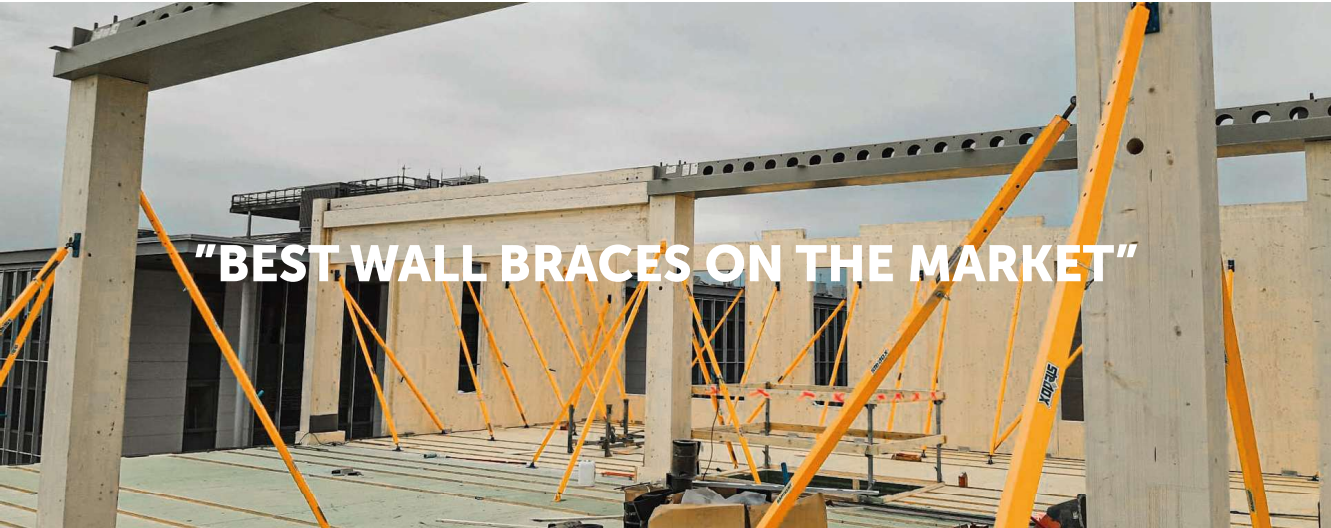

3. General

This operating instruction contains important information on how Stedox® Support safely can be used. It is therefore crucial that the instructions are read prior to use of the wall brace. The operating instructions are always to be held at hand on the construction site. Stedox®-products are intended to be used only by qualified professionals.

Stedox® reserves the right to make technical changes. So work can be performed safely with current legislation, regulations and other safety guidelines. As a contractor you are to ensure that the building and its construction is stable throughout the construction phase. This also includes the erection, dismantling and handling of the wall braces. The building in its entirety is to be inspected after both erection and dismantling of the wall braces.

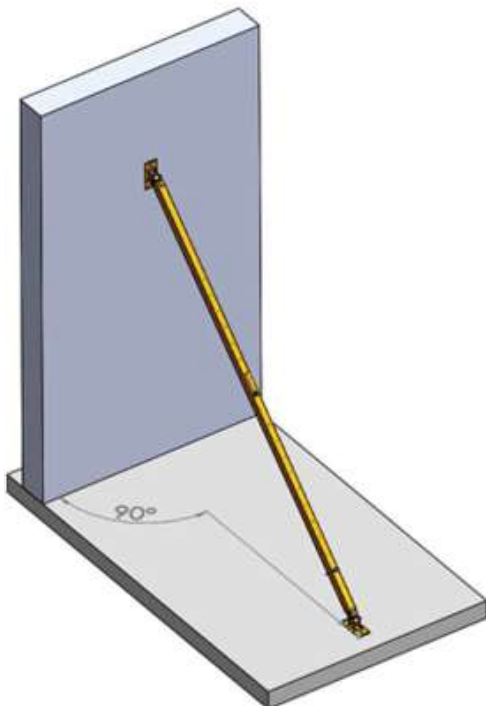

4. Safety and operating instructions

4.1 Symbols

This symbol is used in conjunction with the instructions to place special attention to matters essential from a safety point of view:



Always obey the safety instructions to avoid personal injuries and property damage

4.2 Risk assessment

As a contractor you are always to undertake a risk assessment, that covers the risks associated with the work to be performed. Always work in accordance with the instructions produced from the risk assessment.

4.3 Installation instructions

As a contractor you are always responsible for making the necessary documentation available, regarding the use of the wall braces. Appropriate documentation is this operating instruction and for the job suitable drawings and instructions.



Always use at least two wall brace per element



The wall brace is to be attached above the center of gravity of the element! For tall elements where this is not possible, it is crucial to support them in other ways so the element cannot under any circumstance topple over.



The locking pin must be in place before the wall brace is to be loaded! The wall brace may not be used without a locking pin!



Always attach the wall brace perpendicular to the supported element!

4.4 Use

The wall braces are intended for only professional use. They may only be used by professionals under the supervision of qualified persons. The operating instructions are to be seen as a part of the wall brace. Any addition, exception or deviation from the operating instructions in the use of the wall braces (e.g. the use of other wall braces and methods) is a potential risk where you as a contractor remain solely responsible for any damages. Potential use of other braces, methods or procedures must always be planned accordingly appropriately. Notwithstanding, you as a contractor are responsible for the necessary supplementary planning and documentation that may be needed.



You must always ensure that permissible loads are not exceeded, and where and how the wall braces can be securely fastened.

4.5 Information on the construction site

As a contractor you are to ensure the operating instructions are always available on the construction site. Personnel are to be informed about the contents of the instructions and where they are stored, before using the wall braces.

4.6 Illustrations

The operating instructions depicts parts of a construction under assembly and are henceforth not complete from an occupational safety point of view. You must always follow given safety instructions even if they are not depicted herein.

4.7 Checking the wall brace

Check the wall brace before each use. Stedox® Support may not be modified or changed in any way. A broken or damaged wall brace may not be used.

Checkpoints

- Permanent deformations, e.g.:
 - Stretched holes
 - Dents
 - The straightness of tubes and footplates
- Condition of the threads
- Missing or loose parts
- Locking pin, undamaged and straight
- Tubes move without resistance
- Stop- and maxload decals

Contact customer service if you need support, spares or advice.

If the product is damaged or broken, stop using it immediately. Repair, replace or dispose of it immediately before resuming work.

4.8 Use of other products

The use of other manufacturers products is always associated with a certain risk. The risk assessment is to evaluate each case individually. The situation may require several and/or separate instructions to be compiled.

5. Technical specification

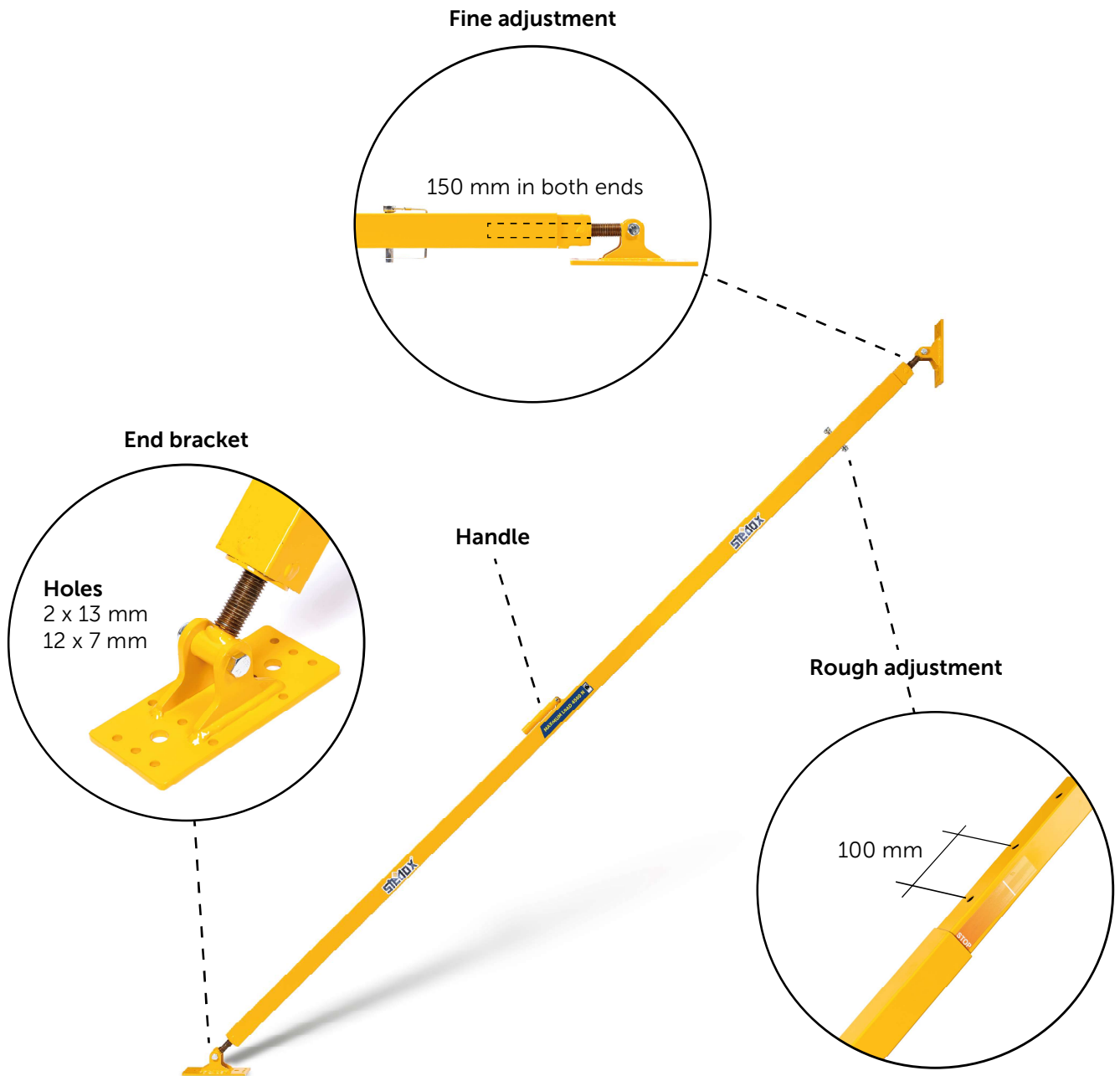

	Stedox® Support 23	Stedox® Support 35
Minimum length (mm)	1900	3000
Maximum length (mm)	3000	5000
Rough adjustment (mm)	c/c 100	c/c 100
Fine adjustment (mm)	300	300
Weight (kg)	12	16
Rust protection	Hot-dip galvanization + powder coating	



The wall brace is always to be attached as high as possible on the element to be supported.

5.1 End bracket geometry

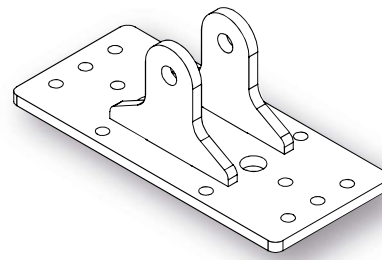
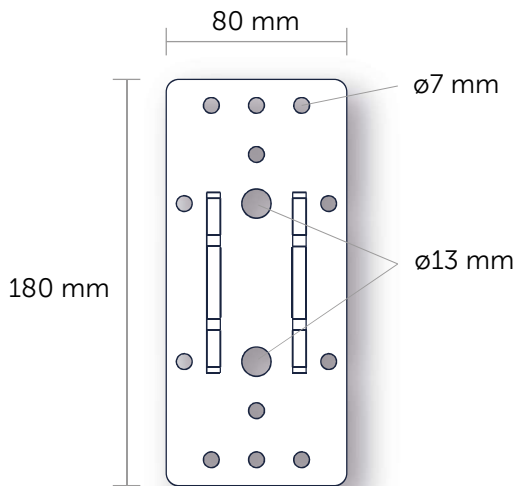

Plate thickness	mm	6
Number of holes	Ø13	2
Number of holes	Ø7	12

6. Structural values

6.1 Load table

Load tables and charts are based on theoretical calculations according to Eurocode 3 standards and real tests conducted in construction labs with calibrated equipment.

Exceeding the maximum permissible load

Extending the wall brace between 2-4 meters while surpassing the maximum allowed load will result in the locking pin hole deforming. If the wall brace is extended beyond 4 meters and the maximum load is exceeded, the wall brace will buckle.



Under no circumstances, the maximum permissible load should be exceeded!

Stedox® Support length [meter]	Stedox® Support 23 2 - 3 m 12 kg			Stedox® Support 35 3 - 5 m 16 kg			
	2	2,5	3	3,5	4	4,5	5
Permissible load [kN] (2 locking pins)	6,3 (12)	6,3 (12)	6,3 (12)	6,3 (9)	6,3 (7)	5,8	4,7

6.2 Load charts

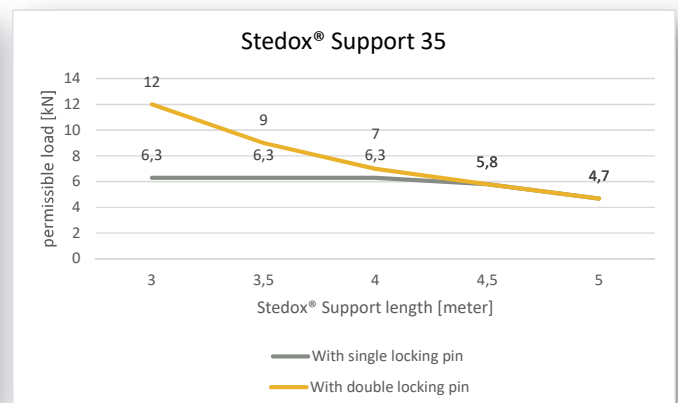
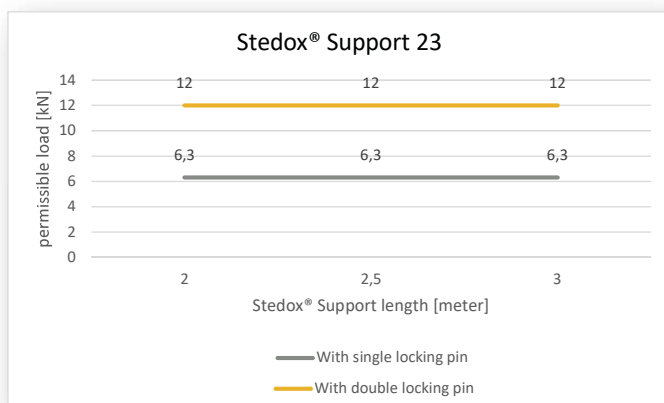

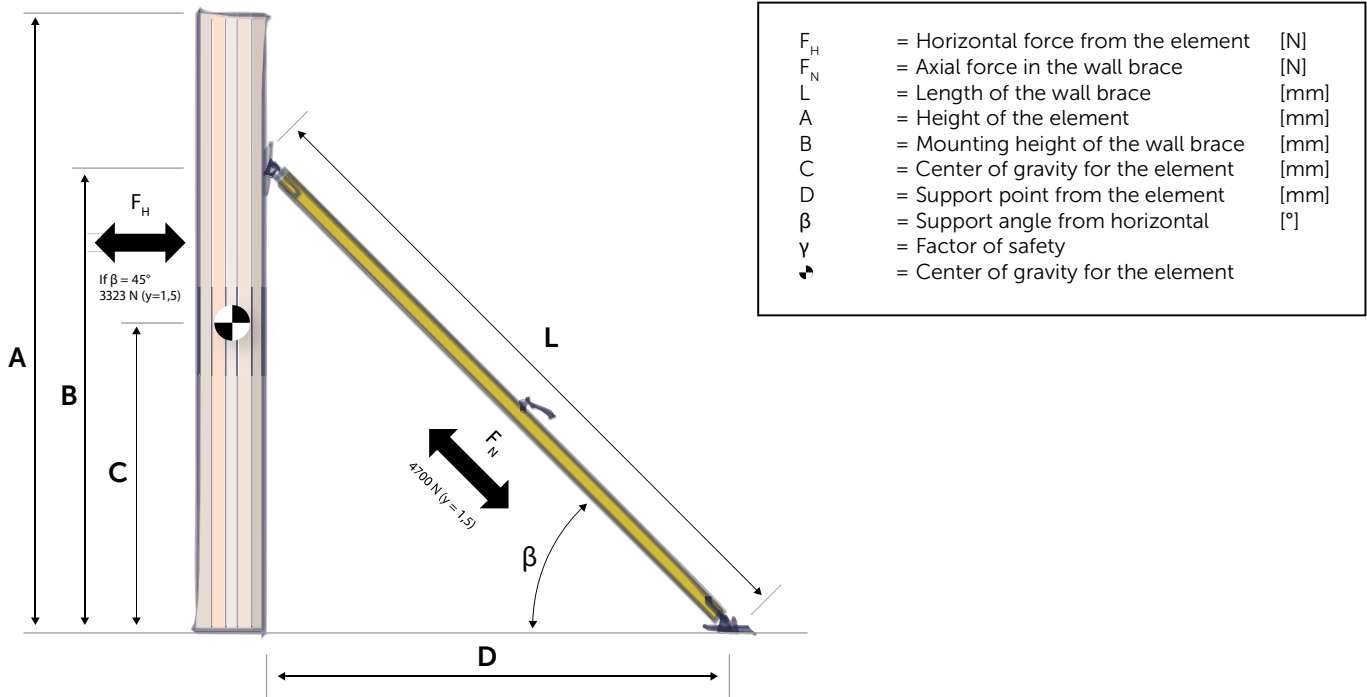

NOTE! The force F_N can be tensile or compressive.

Angle β [°]	$\cos(\beta)$	With safety factor, $\gamma = 1,5$	
		Supporting force F_H [N]	Axial force in the wall brace at 5 meters F_N [N]
30	0,866	4070	4700
35	0,819	3849	
40	0,766	3600	
45	0,707	3323	
50	0,643	3022	
55	0,574	2698	
60	0,5	2350	

The wall brace angle β from horizontal, must be:

$$30^\circ \leq \beta \leq 60^\circ$$

The wall brace fastening height B must be higher than the center of gravity C .

$$B \geq C$$

Recommended that the center of gravity C is at most 2/3 of the fastening height B :

$$B \geq 1,5C$$

The axial load of the wall brace is always to be less than the maximum permissible force including safety factor:

$$F_N \leq \pm 4700 \text{ N}$$

If the element is homogenous the height of its center of gravity can be calculated:

$$C = A / 2$$

The angle from horizontal of the wall brace can be calculated from:

$$\beta = \arctan (B / D)$$

The maximum permissible load in horizontal direction is:

$$F_H = F_N \cdot \cos(\beta)$$



The loads induced on the wall brace originates from the wind load and the skewness of the element. The construction engineer is always to ascertain that permissible loads are not exceeded and where and how the wall brace are to be fastened safely.

7. Note

When the threads in both ends bottom out, extension of the wall brace is to be made through moving the locking pin to the next hole. Before the wall brace can be used, make sure the threads at both ends are equally extended, so the wall brace maximum length can be achieved without damaging it. Both threads can be screwed outwards a maximum of 150 mm each.



Never remove the locking pin unless the element is properly supported by a crane or another suitable support method.

8. Service and spare parts

Only use original spare parts may be used and only qualified persons may maintain and service Stedox® Support. Compatible spare parts can be found from Stedox® website.

Keep the product in good condition by washing and lubricating the threads if they are dirty, rusty or the wall brace has been subjected to moisture. It is recommended that the threads are lubricated and threaded through at least twice per year.

Check the product as specified under chapter 4.7 Checking the wall brace.



Only use original spare parts!

9. Handling

To minimize weight, the wall thickness in the product is thin. It can therefore be dented if handled carelessly.



A broken or damaged product must be replaced or repaired immediately.

10. Storage

Maximum longevity is achieved by storing the product clean and protected from moisture. If the wall brace is subjected to moisture it is reasonable to store it standing so moisture can be drained.

During prolonged storage the product is to be protected from corrosion.

11. In case of an accident

In the event of an accident when using Stedox® Support, do the following in this order:

- Prevent personal injuries
- Prevent property damage
- Inform the person in charge on site

4 REASONS TO CHOOSE STEDOX®

- + Built-in stop function for extra safety
- + Up to 50% more efficient installations
- + Double rust protection ensures a long lifetime for the wall braces
- + Products developed by installation experts



Ready to install your mass timber projects with confidence?

→ Contact Dennis to get started on your next project!